

10 ft (3.05 m) SIT-ON-TOP KAYAKS KAYAKS À COCKPIT OUVERT DE 3,05 m (10 pi)

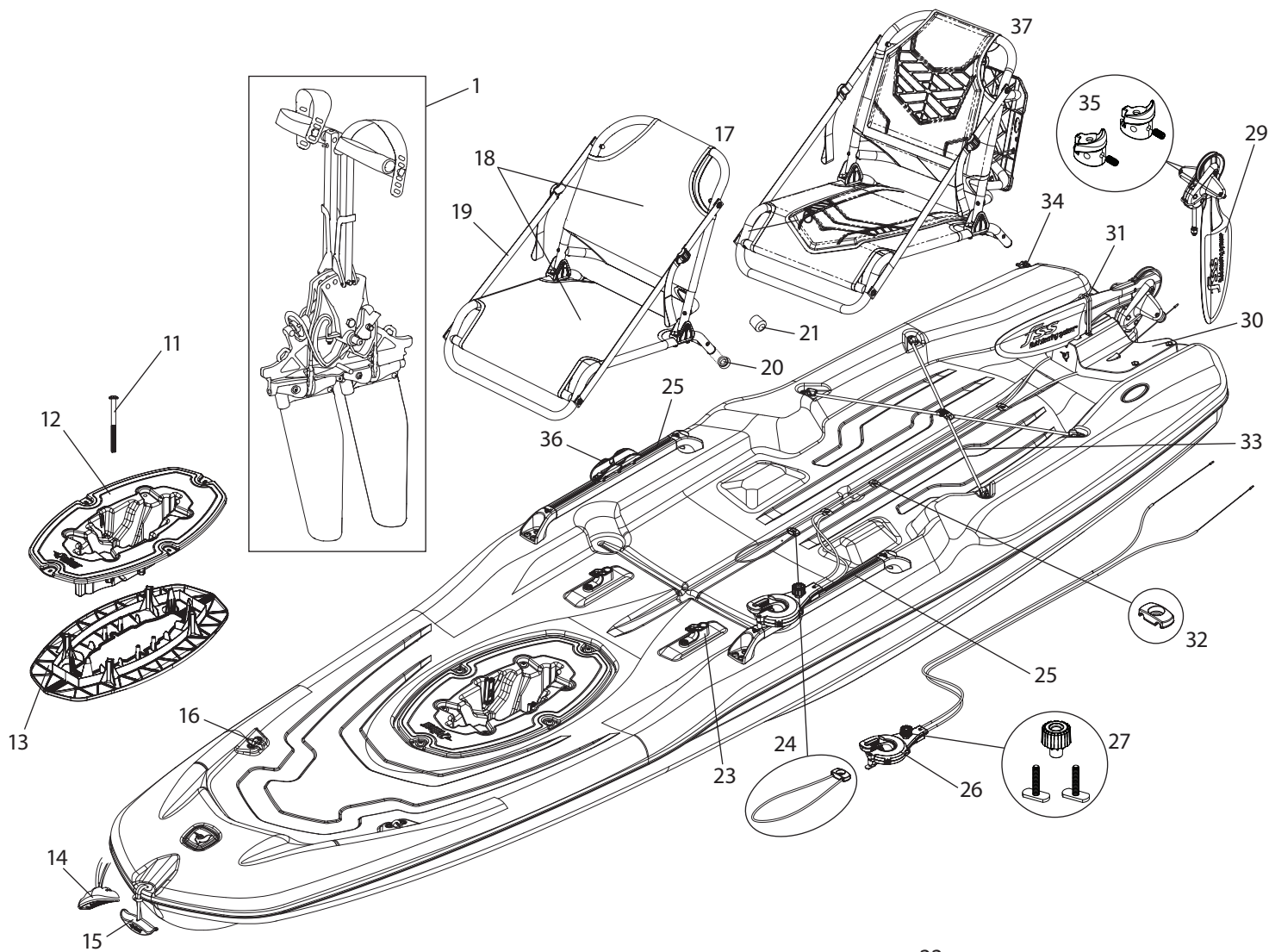

ERGOCAST XP™ & ERGOBOOST GT™ hardware kit - Ensemble de quincaillerie ERGOCAST XP™ et ERGOBOOST GT™







Acorn lock nut / Écrou autobloquant M6	Pan head Phillips screw / Vis à tête cylindrique Phillips M6 x 30 mm	Pan head Phillips screw / Vis à tête cylindrique Phillips M6 x 35 mm	Pan head thread-forming screw for plastic / Vis autoformeuse à tête cylindrique pour plastique M6 x 45 mm	Pan head Phillips sheet metal screw / Vis à tête à tête cylindrique Phillips M2.9 x 9.5 mm	Seat spacer / Rondelle d'espacement	Junction tube / Tube de jonction CT1922-1	ERGO360 & ERGOCAST Fork / Fourche ERGO360 et ERGOCAST
6X	4X	2X	4X	4X	2X	2X	2X

NOTE:
Not all models are equipped with the parts listed above.
All accessories are branded Pelican and designed to fit perfectly on your Pelican kayak. For any additional information contact customer service at 1 888 669-6960 or write to us at support@confluenceoutdoor.com.











NOTE :
Certains modèles ne sont pas équipés des pièces ci-dessus.
Tous les accessoires sont de marque Pelican et ont été conçus pour s'adapter parfaitement à votre kayak Pelican. Pour toutes informations additionnelles contactez le service à la clientèle au 1 888 669-6960 ou écrivez-nous à support@confluenceoutdoor.com.

IPVUEMH10-3

Removable lever hardware kit - Ensemble de quincaillerie pour manette amovible

<p>Rudder lever handle Poignée manette gouvernail</p>  <p>1X</p>	<p>Screw Phillips Rond Head Vis Phillips tête ronde 4-20 x 3/8"</p>  <p>5X</p>	<p>Lever handle fixing screw Vis fixation poignée manette 1/4-20 x 1.25"</p>  <p>1X</p>	<p>Lock nut Écrou autobloquant 1/4-20</p>  <p>1X</p>	<p>Bar stopper Arrêt barre</p>  <p>1X</p>	<p>Handle set screw Vis réglage manette 8/32 x 3/8"</p>  <p>1X</p>
---	---	--	---	--	---

Pedal drive HYDRIVE II™ hardware kit - Ensemble de quincaillerie du système d'entraînement HYDRIVE II™

<p>Flat washer / Rondelle plate 1/4" (3/4"OD)</p>  <p>2X</p>	<p>Locknut / Écrou autobloquant 1/4-20</p>  <p>8X</p>	<p>Phillips rounded head screw / Vis Phillips tête ronde 4-40 x 1-1/2"</p>  <p>2X</p>	<p>Locknut / Écrou autobloquant 4-40</p>  <p>2X</p>	<p>Hex head screw Vis à tête hexagonale 3/8"-24 x 1-1/2"</p>  <p>2X</p>	<p>Flat washer / Rondelle plate 1/4" (5/8"OD)</p>  <p>6X</p>	<p>Locknut / Écrou autobloquant 8-32</p>  <p>2X</p>	<p>Phillips rounded head screw / Vis Phillips tête ronde 8-32 x 5/16"</p>  <p>4X</p>	<p>Flat-tip set screw / Vis de réglage à pointe plate 1/4"-20 x 3/8"</p>  <p>4X</p>	<p>Socket head screw / Vis à tête hexagonale 8-32 x 1/2"</p>  <p>2X</p>	<p>Phillips rounded head screw / Vis Phillips tête ronde 8-32 x 5/8"</p>  <p>2X</p>
---	--	--	--	--	---	--	---	--	--	--

Pedal drive HYDRIVE II™ - Système d'entraînement HYDRIVE II™

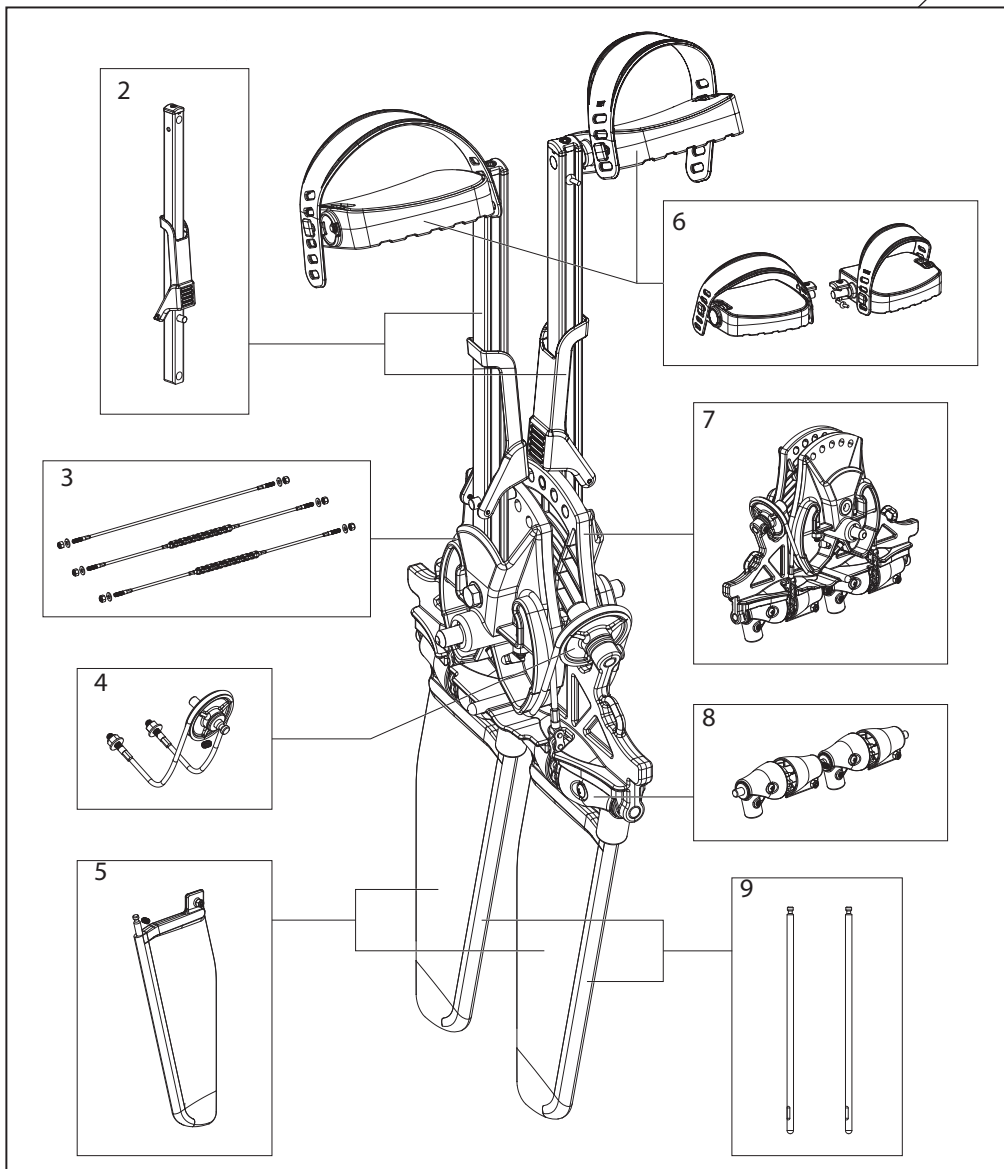

REPLACEMENT PARTS LIST • LISTE DES PIÈCES DE REMPLACEMENT

- | | |
|---|---|
| <p>1. Pedal drive HYDRYVE II™ •
Système d'entraînement HYDRYVE II^{MC}
PS1846-2</p> <p>2. Pedal arm of the pedal drive HYDRYVE II™ •
Bras de pédale du système d'entraînement HYDRYVE II^{MC}
PS1875</p> <p>3. Pedal drive system cable kit •
Ensemble de câbles pour système de pédalier
PS3257-00</p> <p>4. Pedal drive system pulley kit •
Ensemble de poulie pour système de pédalier
PS3256-00</p> <p>5. Fin of the pedal drive HYDRYVE II™ •
Aileron du système d'entraînement HYDRYVE II^{MC}
PS1876-2</p> <p>6. Pedals of the pedal drive HYDRYVE II™ •
Pédales du système d'entraînement HYDRYVE II^{MC}
PS1874</p> <p>7. Mechanism of the pedal drive HYDRYVE II™ •
Mécanisme du système d'entraînement HYDRYVE II^{MC}
PS1849-2</p> <p>8. Pedal drive system sprocket kit •
Ensemble d'engrenage pour système de pédalier
PS3258-00</p> <p>9. HYDRYVE II™ fin rods • Tiges pour aileron HYDRYVE II^{MC}
PS1930-2</p> <p>10. Pedal drive HYDRYVE II™ Hardware kit •
Ensemble de quincaillerie du Système d'entraînement HYDRYVE II^{MC}
PS1830</p> <p>11. HyDryve II™ housing long screw •
Longue vis pour pédalier HyDryve II^{MC}
PS0005</p> <p>12. HyDryve II™ housing - TOP •
Pièce intérieur du pédalier HyDryve II^{MC} - DESSUS
PS1847</p> <p>13. HyDryve II™ housing - BOTTOM •
Pièce intérieur du pédalier HyDryve II^{MC} - DESSOUS
PS1848</p> <p>14. Ergonomic T-handles • Poignées de transport en T
PS1573 PS1473 PS1547
Bright Orange Electric Blue Yellow Green
Orange vif Bleu électrique Citrine</p> <p>15. Standard carrying handles • Poignées de transport standard
PS1584 PS1669
Yellow Green Black
Citrine Noir</p> | <p>16. Accessory eyelet • Oeillet de fixation d'accessoire
PS1210</p> <p>17. ERGOCOAST XP™ portable folding seat •
Banc pliant portatif ERGOCOAST XP^{MC}
PS3001</p> <p>18. ERGOCOAST XP™ seat cover for portable folding seat •
Housse pour banc pliant portatif ERGOCOAST XP^{MC}
PS3005</p> <p>19. ERGOCOAST™ straps • Courroies d'ajustement ERGOCOAST^{MC}
PS1896</p> <p>20. ERGOCOAST™ end-caps •
Embouts tube de la structure du banc ERGOCOAST^{MC}
PS1885</p> <p>21. Set of 2 tube frame end caps •
Ensemble de 2 embouts pour cadre tubulaire
PS3196</p> <p>22. ERGOCOAST XP™ & ERGOBOOST GT™ hardware kit •
Ensemble de quincaillerie ERGOCOAST XP^{MC} et ERGOBOOST GT^{MC}
PS3015</p> <p>23. ERGOCOAST XP™ lock seat • Loquet ERGOCOAST XP^{MC}
PS1329</p> <p>24. 13.5 in. (34.3 cm) bungee cord with cable tie down •
Cordage élastique avec attache câble de 34,3 cm (13,5 po)
PS3007
Black
Noir</p> <p>25. Side handle • Poignée latérale
PS1901</p> <p>26. Removable lever with cable rudder •
Manette amovible avec câble gouvernail
PS3009</p> <p>27. Tightening system for removable lever •
Système de serrage de la manette amovible
PS3010</p> <p>28. Removable lever hardware kit •
Ensemble de quincaillerie pour manette amovible
PS3016</p> <p>29. Rudder • Gouvernail
PS3020</p> <p>30. Rudder support • Support gouvernail
PS3021</p> <p>31. Rudder bungee • Élastique pour gouvernail
PS3022-00</p> <p>32. Cable tie down • Pièce attache câble
PS3023</p> |
|---|---|

REPLACEMENT PARTS LIST • LISTE DES PIÈCES DE REMPLACEMENT (CONTINUED • SUITE)

- | | |
|---|---|
| 33. 19.25 in. (48.9 cm) bungee cord with Cable Tie Down •
Cordage élastique avec attache cable de 48,9 cm (19,25 po)
PS3024
Bright Orange
Orange vif | 36. Paddle clip • Attache pagaie
PS1946-00 |
| 34. Drain plug • Bouchon de drain
PS0145-2 | 37. ERGOBOOST GT™ portable folding seat •
Banc pliant portatif ERGOBOOST GT™
PS3164-00 |
| 35. Support transit rudder • Support transition gouvernail
PS3119-00 | |